



TECHNICAL STANDARDS & SAFETY AUTHORITY
 14th Floor, Centre Tower
 3300 Bloor Street West
 Toronto, Ontario
 Canada M8X 2X4

Show facsimile of manufacturer's logo or trademark, as it will appear on the fitting, in the space below

Swagelok

STATUTORY DECLARATION Registration of Fittings

I, David H. Peace, Vice President of Engineering
(Name and Position, e.g. President, Plant Manager, Chief Engineer)

of Swagelok Company
(Name of Manufacturer)

Located at 29500 Solon Road, Solon, Ohio 44139-3492 (Plant Address) (440) 248-4600 (Telephone No.) 440-519-7384 (Fax No.)

I do solemnly declare that the fittings listed hereunder, which are subject to the **Technical Standards and Safety Act**, Boilers and Pressure Vessels Regulation, comply with all of the requirements of ASME B31.1 and ASME B31.3 for Unlisted Components
(Title of recognized North American Standard)
 which specifies the dimensions, materials of construction, pressure/temperature ratings, identification marking the fittings and service;

or are not covered by the provisions of a recognized North American standard and are therefore manufactured to comply with _____ as supported by the attached data which identifies the dimensions, material of construction, pressure/temperature ratings and the basis for such ratings, the marking of the fitting for identification and service.

I further declare that the manufacture of these fittings is controlled by a quality system meeting the requirements of ISO 9001:2008 which has been verified by the following authority, The British Standards Institution.

The items covered by this declaration, for which I seek registration, are category C type fittings. In support of this application, the following information and/or test data are attached as follows:
ISO 9001:2008 Certificate, Catalog Information, Support Documents, Attachment B, Attachment A
(drawings, calculations, test reports, etc.)

Declared before me at Solon in the State of Ohio
 the 01st day of April AD 2015.

Commissioner for Oaths: Jamie L. Ristau (Printed name)
Jamie L. Ristau (Signature)
 Jamie L. Ristau
 Resident Portage County
 Notary Public, State of Ohio
 My Commission Expires: 03/08/2019
[Signature] (Signature of Declarer)

FOR OFFICE USE ONLY

To the best of my knowledge and belief, the application meets the requirements of the **Technical Standards and Safety Act**, Boilers and Pressure Vessels Regulation, and CSA Standard B51 and is accepted for registration in Category C

CRN: CSA-OC18924.56
 Registered by: R.W. BARNES
 Dated: MAY 30, 2017

REGISTERED

CRN: CSA-OC18924.56

Registration Process administered by
CSA Group per CSA B51

NOTE: This registration expires on: NOV. 14. 2026



Note: 1. This registration is based on a technical review performed by the province of initial registration in accordance with CSA B51 policy on reciprocal recognition of design review.
 2. See attached scope of registration.

u

Attachment B1. Scope for Swagelok Special Alloy 60 Series Ball Valves (Category C)

This document represents the scope of the Swagelok Special Alloy 60 Series Ball Valves covered by this submission for CRN approval. The Swagelok Special Alloy 60 Series Valves were designed and evaluated in accordance with ASME B31.1 for unlisted components and ASME B31.3 for unlisted components.

Summary Table

Product Description or Series	Main Pressure Bearing Component	Main Pressure Bearing Material (Standard)	Port Connections and Sizes	Maximum Rated Pressure		Design Code of Construction
				At ambient temperature	At maximum temperature	
63	Body	Stainless Steel 6MO (ASTM A276 UNS S31254)	Swagelok Tube Fitting 1/2" Female NPT 1/2"	2,200 psi @ 100 °F	100 psi @ 450 °F	ASME B31.1 (Unlisted Components) and ASME B31.3 (Unlisted Components)
		Stainless Steel 2507 (ASTM A479 UNS S32750)	Swagelok Tube Fitting 1/2" Female NPT 1/2"	2,200 psi @ 100 °F	100 psi @ 450 °F	ASME B31.1 (Unlisted Components) and ASME B31.3 (Unlisted Components)
		Alloy 825 (ASTM B425 UNS N08825)	Swagelok Tube Fitting 1/2" Female NPT 1/2"	2,200 psi @ 100 °F	100 psi @ 450 °F	ASME B31.1 (Unlisted Components) and ASME B31.3 (Unlisted Components)
		Alloy 625 (ASTM B446 UNS N06625)	Swagelok Tube Fitting 1/2" Female NPT 1/2"	2,200 psi @ 100 °F	100 psi @ 450 °F	ASME B31.1 (Unlisted Components) and ASME B31.3 (Unlisted Components)

For more information about pressure ratings of valves with tube fitting end connections, see Swagelok Tubing Data, MS-01-107.

Product Illustrations

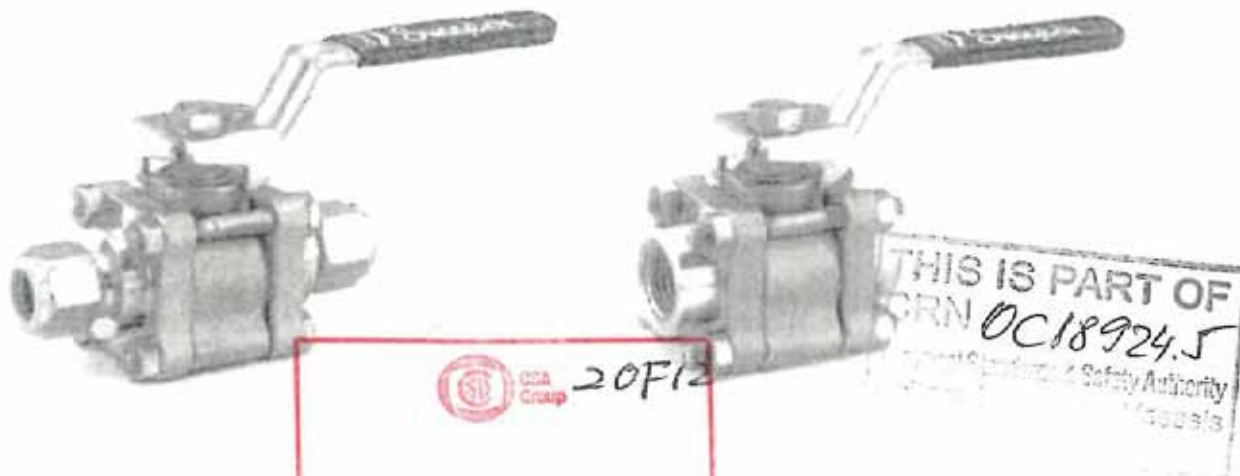

 20F12
ATTACHMENT TO
CRN: 0C18924.56
 Signed: *[Signature]*
 178 Rexdale Boulevard, Toronto, ON Canada M9W 1R3

Product Options:

The product options listed below affect pressure and/or temperature ratings shown in the above Summary Table, but in all cases the ratings are less than those shown in the table.

Flange Seal Material Options

Fluorocarbon, FKM
Buna N
Buna C
Ethylene Propylene
Neoprene
Grafoil
PTFE

Stem Seal Material Options

PTFE, virgin
Fluorocarbon, FKM
Buna C
Ethylene Propylene
Grafoil

Seat Material Options

PTFE, virgin
PTFE, reinforced
PTFE, carbon glass filled
PEEK
UHMWPE



Additional options and non-pressure boundary alterations that do not affect pressure-temperature ratings may be made available within the scope of this registration. Examples of these would include the following:

Handle options
Actuators (e.g. pneumatic, electric)
Panel mounting
Low dead space inserts

All of the above options, those that affect pressure and/or temperature ratings and those that do not, are within the scope of this approval.

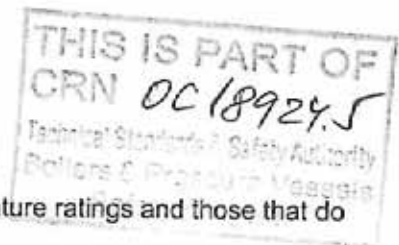
**Quality System**

The Swagelok Company quality system complies with the requirements of BS EN ISO 9001:2008. The Swagelok Company maintains British Standards Institution Certificate of Registration Number FM 01729, which applies to all locations listed on the Certificate. The Special Alloy 60 Series Ball Valves products are made at a Swagelok Company location in Solon, Ohio.

References

The product catalog does not represent the full scope of registration, but rather details some of the most common options.

- 60 Series Ball Valves – Special-Alloy Fluid System Components Catalog MS-02-439

Attachment B2. Scope for Swagelok Special Alloy 83 Series Ball Valves (Category C)

This document represents the scope of the Swagelok Special Alloy 83 Series Ball Valves covered by this submission for CRN approval. The Swagelok Special Alloy 83 Series Ball Valves were designed and evaluated in accordance with ASME B31.1 for unlisted components and ASME B31.3 for unlisted components.

Summary Table

Product Description or Series	Main Pressure Bearing Component	Main Pressure Bearing Material (Standard)	Port Connections and Sizes	Maximum Rated Pressure		Design Code of Construction
				At ambient temperature	At maximum temperature	
83	Body	Stainless Steel 2507 (ASTM A479 UNS S32750)	Swagelok Tube Fitting 1/4", 3/8", 1/2", 6MM, 8MM, 10MM, 12MM Female NPT 1/8", 1/4", 1/2"	6,000 psi @ 100 °F	500 psi @ 450 °F	ASME B31.1 (Unlisted Components) and ASME B31.3 (Unlisted Components)
		Alloy 825 (ASTM B425 UNS N08825)	Swagelok Tube Fitting 1/4", 3/8", 1/2", 6MM, 8MM, 10MM, 12MM Female NPT 1/8", 1/4", 1/2"	6,000 psi @ 100 °F	500 psi @ 450 °F	ASME B31.1 (Unlisted Components) and ASME B31.3 (Unlisted Components)

For more information about pressure ratings of valves with tube fitting end connections, see Swagelok Tubing Data, MS-01-107.

Product Illustrations



THIS IS PART OF
CRN *OC189245*
The above information is for informational purposes only.
© 2012 Swagelok Company

 **40F12**

ATTACHMENT TO
CRN: *CSA-OC1892456*
Signed: *[Signature]*
178 Rexdale Boulevard, Toronto, ON Canada M9W 1R3

Product Options

Additional options that do not affect pressure-temperature ratings may be made available within the scope of this registration. Examples of these would include 3-way valves, seat materials, stem seal materials, actuators.

Quality System

The Swagelok Company quality system complies with the requirements of BS EN ISO 9001:2008. The Swagelok Company maintains British Standards Institution Certificate of Registration Number FM 01729, which applies to all locations listed on the Certificate. Special Alloy 83 Series Ball Valves products are made at a Swagelok Company location in Solon, Ohio.

References

The product catalog does not represent the full scope of registration, but rather details some of the most common options.

- 83 Series Ball Valves – Special-Alloy Fluid System Components Catalog MS-02-357

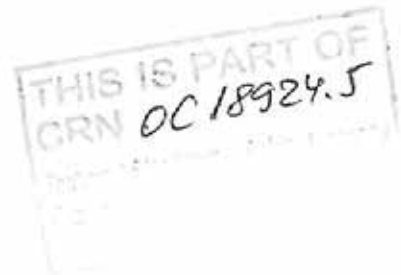

Attachment B3. Scope for Swagelok Special Alloy Bleed Valves (Category C)

This document represents the scope of the Swagelok Special Alloy Bleed Valves covered by this submission for CRN approval. The Swagelok Special Alloy Bleed Valves were designed and evaluated in accordance with ASME B31.1 for unlisted components and ASME B31.3 for unlisted components.

Summary Table

Product Description or Series	Main Pressure Bearing Component	Main Pressure Bearing Material (Standard)	Port Connections and Sizes	Maximum Rated Pressure		Design Code of Construction
				At ambient temperature	At maximum temperature	
BV	Body	Stainless Steel 2507 (ASTM A479 UNS S32750)	Male NPT 1/4", 3/8", 1/2"	10,000 psi @ 100 °F	8,965 psi @ 482 °F	ASME B31.1 (Unlisted Components) and ASME B31.3 (Unlisted Components)
		Alloy 625 (ASTM B446 UNS N06625)	Male NPT 1/4", 3/8", 1/2"	10,000 psi @ 100 °F	7,490 psi @ 850 °F	ASME B31.1 (Unlisted Components) and ASME B31.3 (Unlisted Components)
		Alloy 825 (ASTM B425 UNS N08825)	Male NPT 1/4", 3/8", 1/2"	10,000 psi @ 100 °F	7,295 psi @ 850 °F (Note 1)	ASME B31.1 (Unlisted Components) and ASME B31.3 (Unlisted Components)
		Hastelloy C (ASTM B574 UNS N10276)	Male NPT 1/4", 3/8", 1/2"	10,000 psi @ 100 °F	6,155 psi @ 850 °F	ASME B31.1 (Unlisted Components) and ASME B31.3 (Unlisted Components)

Notes:

(1) For ASME B31.1 applications, this product is rated to 7,295 psi @ 800°F.

Product Illustrations



60F12

CSA Group

ATTACHMENT TO
C.R.N. CSA-0618924.56

Signed: W. Barnes

178 Rexdale Boulevard, Toronto, ON Canada M9W 1R7

THIS IS PART OF
CRN 0618924.5

Typical Product Characteristics:

Some of the product options listed below affect the pressure-temperature ratings shown in the Summary Table, but in all cases the ratings are less than those shown in the Summary Table. All of the following options are within the scope of this registration:

Typical Options

Handles
Vent Tubes

Additional options and non-pressure boundary alterations that do not affect pressure-temperature ratings may be made available within the scope of this registration. Examples of these would include handle options, actuator options, etc.

Quality System

The Swagelok Company quality system complies with the requirements of BS EN ISO 9001:2008. The Swagelok Company maintains British Standards Institution Certificate of Registration Number FM 01729, which applies to all locations listed on the Certificate. The Special Alloy Bleed Valves products are made at a Swagelok Company location in Solon, Ohio.

References

The product catalog does not represent the full scope of registration, but rather details some of the most common options.

- BV Bleed Valves - Special Alloy Materials Catalog MS-02-356

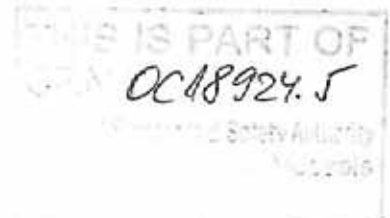

Attachment B4. Scope for Swagelok Special Alloy CH Series Check Valves (Category C)

This document represents the scope of the Swagelok Special Alloy CH Series Check Valves covered by this submission for CRN approval. The Swagelok Special Alloy Check Valves were designed and evaluated in accordance with ASME B31.1 for unlisted components and ASME B31.3 for unlisted components.

Summary Table

Product Description or Series	Main Pressure Bearing Component	Main Pressure Bearing Material (Standard)	Port Connections and Sizes	Maximum Rated Pressure		Design Code of Construction
				At ambient temperature	At maximum temperature	
CH	Body	Alloy 625 (ASTM B446 UNS N06625)	Swagelok Tube Fitting 1/4", 3/8", 1/2" Female NPT 1/4", 3/8", 1/2" Male NPT 1/4", 3/8", 1/2"	6,000 psi @ 100 °F	5070 psi @ 400 °F	ASME B31.1 (Unlisted Components) and ASME B31.3 (Unlisted Components)
		Alloy 625 (ASTM B425 UNS N08825)	Swagelok Tube Fitting 1/4", 3/8", 1/2" Female NPT 1/4", 3/8", 1/2" Male NPT 1/4", 3/8", 1/2"	6,000 psi ① @ 100 °F	4995 psi @ 400 °F	ASME B31.1 (Unlisted Components) and ASME B31.3 (Unlisted Components)
		Stainless Steel 2507 (ASTM A479 UNS S32750)	Swagelok Tube Fitting 1/4", 3/8", 1/2" Female NPT 1/4", 3/8", 1/2" Male NPT 1/4", 3/8", 1/2"	6,000 psi @ 100 °F	5455 psi @ 400 °F	ASME B31.1 (Unlisted Components) and ASME B31.3 (Unlisted Components)

For more information about pressure ratings of valves with tube fitting end connections, see Swagelok Tubing Data, MS-01-107.

① Pressure ratings for valves with 1/2 in. female NPT end connections limited to 5700 psig (392 bar).

Product Illustrations

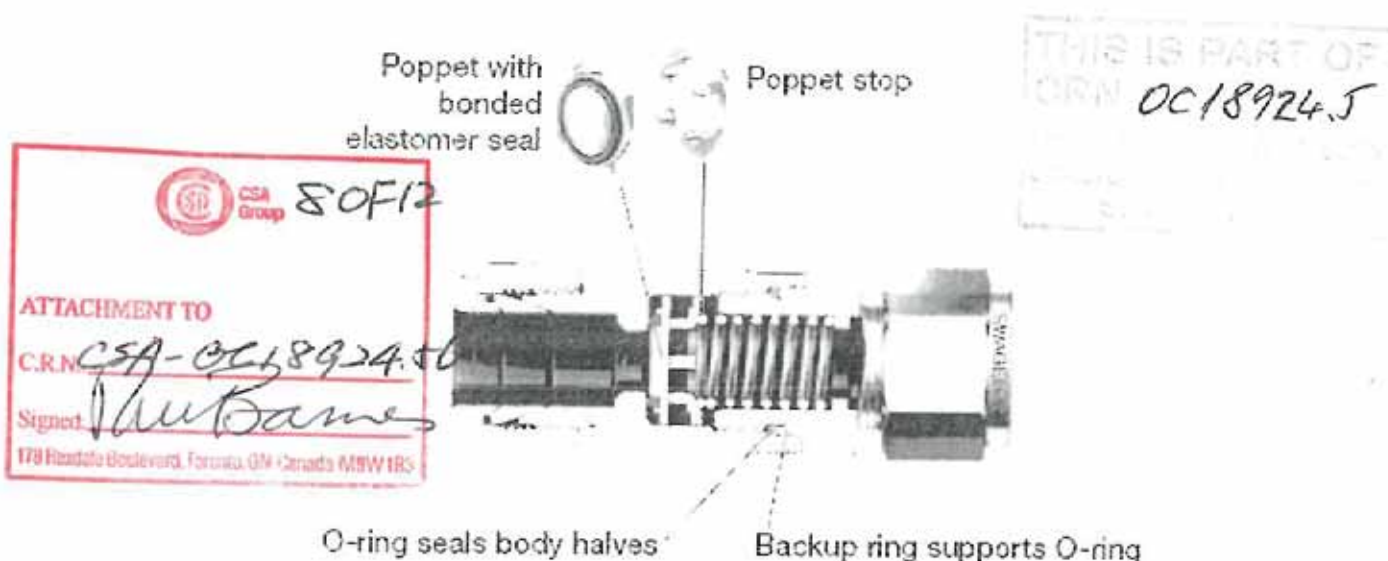

Product Options:

Additional options that do not affect pressure-temperature ratings may be made available within the scope of this registration. Examples of these would include poppet springs and body seal materials.

Quality System

The Swagelok Company quality system complies with the requirements of BS EN ISO 9001:2008. The Swagelok Company maintains British Standards Institution Certificate of Registration Number FM 01729, which applies to all locations listed on the Certificate. The Special Alloy Bleed Valves products are made at a Swagelok Company location in Solon, Ohio.

References

The product catalog does not represent the full scope of registration, but rather details some of the most common options.

- Check Valves – Special Alloy Materials – CH Series Catalog MS-02-440

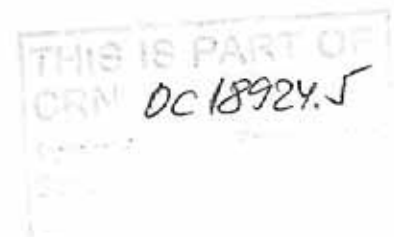
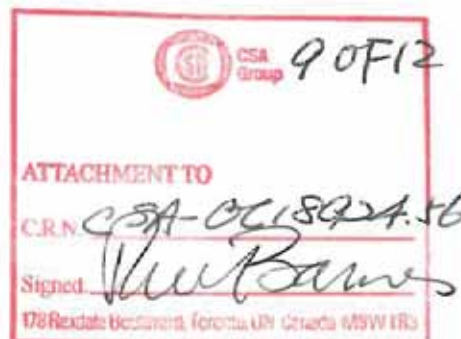

Attachment B5. Scope for Swagelok Special Alloy N and HN Series Needle Valves (Category C)

This document represents the scope of the Swagelok Special Alloy N and HN Needle Valves covered by this submission for CRN approval. The Swagelok Special Alloy N and HN Needle Valves were designed and evaluated in accordance with ASME B31.1 for unlisted components and ASME B31.3 for unlisted components.

Summary Table

Product Description or Series	Main Pressure Bearing Component	Main Pressure Bearing Material (Standard)	Port Connections and Sizes	Maximum Rated Pressure		Design Code of Construction
				At ambient temperature	At maximum temperature	
3N	Body	Stainless Steel 2507 (ASTM A479 UNS S32750)	Female NPT 1/8", 1/4" Male NPT 1/4" Swagelok Tube Fitting 1/4", 6MM	6,000 psi @ 100 °F	5,370 psi @ 482 °F	ASME B31.1 (Unlisted Components) ASME B31.3 (Unlisted Components)
		Alloy 825 (ASTM B425 UNS N08825)	Female NPT 1/8", 1/4" Male NPT 1/4" Swagelok Tube Fitting 1/4", 6MM	6,000 psi @ 100 °F	4,250 psi @ 1000 °F (Note 1)	ASME B31.1 (Unlisted Components) ASME B31.3 (Unlisted Components)
6N	Body	Alloy 825 (ASTM B425 UNS N08825)	Female NPT 1/4", 3/8" Swagelok Tube Fitting 3/8", 1/2", 10MM, 12MM	6,000 psi @ 100 °F	4,250 psi @ 1000 °F (Note 1)	ASME B31.1 (Unlisted Components) ASME B31.3 (Unlisted Components)
		Stainless Steel 6MO (ASTM A182 UNS S31254)	Female NPT 1/4", 3/8" Swagelok Tube Fitting 3/8", 1/2", 10MM, 12MM	6,000 psi @ 100 °F	3,860 psi @ 750 °F	ASME B31.1 (Unlisted Components) ASME B31.3 (Unlisted Components)
12N	Body	Alloy 825 (ASTM B425 UNS N08825)	Female NPT 1/2", 3/4", 1" Male NPT 1/2", 3/4", 1" Swagelok Tube Fitting 1/2", 3/4", 12MM	6,000 psi @ 100 °F	4,250 psi @ 1000 °F (Note 1)	ASME B31.1 (Unlisted Components) ASME B31.3 (Unlisted Components)
		Stainless Steel 6MO (ASTM A182 UNS S31254)	Female NPT 1/2", 3/4", 1" Male NPT 1/2", 3/4", 1" Swagelok Tube Fitting 1/2", 3/4", 12MM	6,000 psi @ 100 °F	3,860 psi @ 750 °F	ASME B31.1 (Unlisted Components) ASME B31.3 (Unlisted Components)

Notes:

(1) For ASME B31.1 applications, this product is rated to 4,380 psi @ 800°F.

For more information about pressure ratings of valves with tube fitting end connections, see Swagelok® Tubing Data, MS-01-107.

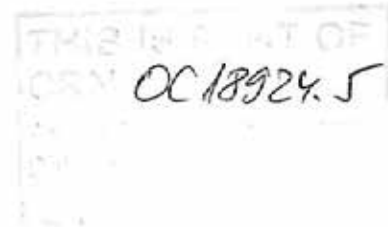

Product Description or Series	Main Pressure Bearing Component	Main Pressure Bearing Material (Standard)	Port Connections and Sizes	Maximum Rated Pressure		Design Code of Construction
				At ambient temperature	At maximum temperature	
3HN	Body	Stainless Steel 2507 (ASTM A479 UNS S32750)	Female NPT 1/8", 1/4" Male NPT 1/4" Swagelok Tube Fitting 1/4", 6MM	10,000 psi @ 100 °F	8,960 psi @ 482 °F	ASME B31.1 (Unlisted Components) ASME B31.3 (Unlisted Components)
		Alloy 825 (ASTM B425 UNS N08825)	Female NPT 1/8", 1/4" Male NPT 1/4" Swagelok Tube Fitting 1/4", 6MM	10,000 psi @ 100 °F	7,080 psi @ 1000 °F (Note 1)	ASME B31.1 (Unlisted Components) ASME B31.3 (Unlisted Components)
6HN	Body	Stainless Steel 2507 (ASTM A479 UNS S32750)	Female NPT 1/4", 1/2" Male NPT 1/2" Swagelok Tube Fitting 3/8", 1/2"	10,000 psi @ 100 °F	8,960 psi @ 482 °F	ASME B31.1 (Unlisted Components) ASME B31.3 (Unlisted Components)

Notes:

(1) For ASME B31.1 applications, this product is rated to 7,295 psi @ 800°F.

For more information about pressure ratings of valves with tube fitting end connections, see Swagelok® Tubing Data, MS-01-107.

Product Illustrations



CSA Group 110F12
 ATTACHMENT TO
 C.R.N. CSA-0018924.56
 Signed: [Signature]
 177 Rexdale Boulevard, Toronto, ON Canada M9W 1R5

THIS IS PART OF
 CRN 0018924.5

Typical Product Characteristics

Some of the product options listed below affect the pressure-temperature ratings shown in the Summary Table, but in all cases the ratings are less than those shown. All of the following options are within the scope of this registration:

Typical Options

Handles
Vent Tubes

Additional options and non-pressure boundary alterations that do not affect pressure-temperature ratings may be made available within the scope of this registration. Examples of these would include handle options, actuator options, etc.

Product Options

Additional options that do not affect pressure-temperature ratings may be made available within the scope of this registration. Examples of these would include stem packing seal materials, stem tip, and handle options.

Quality System

The Swagelok Company quality system complies with the requirements of BS EN ISO 9001:2008. The Swagelok Company maintains British Standards Institution Certificate of Registration Number FM 01729, which applies to all locations listed on the Certificate. Special Alloy N and HN Needle Valve products are made at a Swagelok Company location in Solon, Ohio.

References

The product catalog does not represent the full scope of registration, but rather details some of the most common options.

- N, HN Bleed Valves - Special Alloy Materials Catalog MS-02-365



THIS IS PART OF
GEN DC18924.5